

INSTRUCTION MANUAL

DEWALT®

DCT410-XE, DCT411-XE

10.8 V CORDLESS INSPECTION CAMERA



Definitions: Safety Guidelines

The definitions below describe the level of severity for each signal word. Please read the manual and pay attention to these symbols.

▲DANGER: Indicates an imminently hazardous situation which, if not avoided, **will** result in **death or serious injury**.

▲WARNING: Indicates a potentially hazardous situation which, if not avoided, **could** result in **death or serious injury**.

▲CAUTION: Indicates a potentially hazardous situation which, if not avoided, **may** result in **minor or moderate injury**.

NOTICE: indicates a practice **not related to personal injury** which, if not avoided, **may** result in **property damage**.

IF YOU HAVE ANY QUESTIONS OR COMMENTS ABOUT THIS OR ANY DEWALT TOOL, CALL US AT: **1800 444 224** (Aust) or **0800 339 258** (NZ).

SAFETY INSTRUCTIONS FOR POWER TOOLS

When using power tools, always observe the safety regulations applicable in your country to reduce the risk of fire, electric shock and personal injury. Read the following safety instructions before attempting to operate this product. Keep these instructions in a safe place.



WARNING: To reduce the risk of injury, read the instruction manual.

GENERAL POWER TOOL SAFETY WARNINGS



WARNING! Read all safety warnings and all instructions Failure to follow the warnings and instructions may result in electric shock, fire and/or serious injury.

The term “power tool” in the warnings refers to your mains-operated (corded) power tool or battery-operated (cordless) power tool.

SAVE THESE INSTRUCTIONS

1) WORK AREA SAFETY

- a) **Keep work area clean and well lit.** Cluttered or dark areas invite accidents.
- b) **Do not operate power tools in explosive atmospheres, such as in the presence of flammable liquids, gases or dust.** Power tools create sparks which may ignite the dust or fumes.
- c) **Keep children and bystanders away while operating a power tool.** Distractions can cause you to lose control.

2) ELECTRICAL SAFETY

- a) **Power tool plugs must match the outlet. Never modify the plug in any way. Do not use any adapter plugs with earthed (grounded) power tools.** Unmodified plugs and matching outlets will reduce risk of electric shock.
- b) **Avoid body contact with earthed or grounded surfaces such as pipes, radiators, ranges and refrigerators.** There is an increased risk of electric shock if your body is earthed or grounded.
- c) **Do not expose power tools to rain or wet conditions.** Water entering a power tool will increase the risk of electric shock.
- d) **Do not abuse the cord. Never use the cord for carrying, pulling or unplugging the power tool. Keep cord away from heat, oil, sharp edges or moving parts.** Damaged or entangled cords increase the risk of electric shock.
- e) **When operating a power tool outdoors, use an extension cord suitable for outdoor use.** Use of a cord suitable for outdoor use reduces the risk of electric shock.

3) PERSONAL SAFETY

- a) **Stay alert, watch what you are doing and use common sense when operating a power tool. Do not use a power tool while you are tired or under the influence of drugs, alcohol or medication.** A moment of inattention while operating power tools may result in serious personal injury.
- b) **Use safety equipment. Always wear eye protection.** Protective equipment such as dust mask, non-skid safety shoes, hard hat, or hearing protection used for appropriate conditions will reduce personal injuries.

- c) **Prevent unintentional starting. Ensure the switch is in the off position before plugging in.** Carrying power tools with your finger on the switch or plugging in power tools that have the switch on invites accidents.
- d) **Remove any adjusting key or wrench before turning the power tool on.** A wrench or a key left attached to a rotating part of the power tool may result in personal injury.
- e) **Do not overreach. Keep proper footing and balance at all times.** This enables better control of the power tool in unexpected situations.
- f) **Dress properly. Do not wear loose clothing or jewellery. Keep your hair, clothing and gloves away from moving parts.** Loose clothes, jewellery or long hair can be caught in moving parts.
- g) **If devices are provided for the connection of dust extraction and collection facilities, ensure these are connected and properly used.** Use of dust collection can reduce dust-related hazards.

4) POWER TOOL USE AND CARE

- a) **Do not force the power tool. Use the correct power tool for your application.** The correct power tool will do the job better and safer at the rate for which it was designed.
- b) **Do not use the power tool if the switch does not turn it on and off.** Any power tool that cannot be controlled with the switch is dangerous and must be repaired.
- c) **Disconnect the plug from the power source and/or the battery pack from the power tool before making any adjustments, changing accessories, or storing power tools.** Such preventive safety measures reduce the risk of starting the power tool accidentally.
- d) **Store idle power tools out of the reach of children and do not allow persons unfamiliar with the power tool or these instructions to operate the power tool.** Power tools are dangerous in the hands of untrained users.
- e) **Maintain power tools. Check for misalignment or binding of moving parts, breakage of parts and any other condition that may affect the power tool's operation. If damaged, have the power tool repaired before use.** Many accidents are caused by poorly maintained power tools.
- f) **Keep cutting tools sharp and clean.** Properly maintained cutting tools with sharp cutting edges are less likely to bind and are easier to control.

- g) **Use the power tool, accessories and tool bits etc., in accordance with these instructions and in the manner intended for the particular type of power tool, taking into account the working conditions and the work to be performed.** Use of the power tool for operations different from those intended could result in a hazardous situation.

5) BATTERY TOOL USE AND CARE

- a) **Recharge only with the charger specified by the manufacturer.** A charger that is suitable for one type of battery pack may create a risk of fire when used with another battery pack.
- b) **Use power tools only with specifically designated battery packs.** Use of any other battery packs may create a risk of injury and fire.
- c) **When battery pack is not in use, keep it away from other metal objects like paper clips, coins, keys, nails, screws, or other small metal objects that can make a connection from one terminal to another.** Shorting the battery terminals together may cause burns or a fire.
- d) **Under abusive conditions, liquid may be ejected from the battery; avoid contact. If contact accidentally occurs, flush with water. If liquid contacts eyes, additionally seek medical help.** Liquid ejected from the battery may cause irritation or burns.

6) SERVICE

- a) **Have your power tool serviced by a qualified repair person using only identical replacement parts.** This will ensure that the safety of the power tool is maintained.

Electrical Safety

The electric motor has been designed for one voltage only. Always check that the power supply corresponds to the voltage on the rating plate. 240 V AC means your tool will operate on alternating current. As little as 10% lower voltage can cause loss of power and can result in overheating. All DeWALT tools are factory tested; if this tool does not operate, check the power supply. Your DeWALT tool is double insulated, therefore no earth wire is required.

- **Young children and the infirm.** This appliance is not intended for use by young children or infirm persons without supervision. Young children should be supervised to ensure that they do not play with this appliance.

- **Replacement of the supply cord.** If the supply cord is damaged, it must be replaced by the manufacturer or an authorised DEWALT Service Centre in order to avoid a hazard.

Extension Cords

⚠ CAUTION: Use only extension cords that are approved by the country's Electrical Authority. Before using extension cords, inspect them for loose or exposed wires, damaged insulation and defective fittings. Replace the cord if necessary.

MINIMUM GAUGE FOR CORD SETS						
For Cable length (m):	7.5	15	25	30	45	60
Use Cable with minimum rating (Amperes)						
Tool Amperes						
0 - 3.4	7.5	7.5	7.5	7.5	7.5	7.5
3.5 - 5.0	7.5	7.5	7.5	7.5	10	15
5.1 - 7.0	10	10	10	10	15	15
7.1 - 12.0	15	15	15	15	20	20
12.1 - 20.0	20	20	20	20	25	–

ADDITIONAL SPECIFIC SAFETY RULES

- **Wear ear protectors with impact drills.** Exposure to noise can cause hearing loss.
- Use auxiliary handles supplied with the tool. Loss of control can cause personal injury.
- **Hold power tools by insulated gripping surfaces when performing an operation where the cutting tool may contact hidden wiring or its own cord.** Contact with a "live" wire will make exposed metal parts of the tool "live" and shock the operator.
- Use clamps or another practical way to secure and support the workpiece to a stable platform. Holding the work by hand or against your body leaves it unstable and may lead to loss of control.
- **Air vents often cover moving parts and should be avoided.** Loose clothes, jewelry or long hair can be caught in moving parts..

⚠ WARNING: ALWAYS wear approved protective safety equipment complying with the following standards:

- Eye protection: AS/NZS1337 Eye Protectors for Industrial Applications;

- Hearing protection: AS/NZS1270 Acoustics – Hearing Protection;
- Respiratory protection: AS/NZS1716 Respiratory Protective Devices.

⚠ WARNING: Some dust created by power sanding, sawing, grinding, drilling, and other construction activities contains chemicals known to cause cancer, birth defects or other reproductive harm. Some examples of these chemicals are:

- lead from lead-based paints,
- crystalline silica from bricks and cement and other masonry products, and
- arsenic and chromium from chemically-treated lumber.

Your risk from these exposures varies, depending on how often you do this type of work. To reduce your exposure to these chemicals: work in a well ventilated area, and work with approved safety equipment, such as those dust masks that are specially designed to filter out microscopic particles.

- **Avoid prolonged contact with dust from power sanding, sawing, grinding, drilling, and other construction activities. Wear protective clothing and wash exposed areas with soap and water.** Allowing dust to get into your mouth, eyes, or lay on the skin may promote absorption of harmful chemicals.

⚠ WARNING: Use of this tool can generate and/or disburse dust, which may cause serious and permanent respiratory or other injury. Always use NIOSH/OSHA approved respiratory protection appropriate for the dust exposure. Direct particles away from face and body.



⚠ WARNING: We recommend the use of a residual current device with a residual current rating of 30mA or less.

⚠ WARNING: Always wear proper personal hearing protection that conforms to AS/NZS1270 during use. Under some conditions and duration of use, noise from this product may contribute to hearing loss.

⚠ CAUTION: When not in use, place tool on its side on a stable surface where it will not cause a tripping or falling hazard. Some tools with large battery packs will stand upright on the battery pack but may be easily knocked over.

- The label on your tool may include the following symbols. The symbols and their definitions are as follows:

V	volts	A	amperes
Hz	hertz	W	watts
min	minutes	~	alternating current

— — — direct current	⎓ alternating or direct current
 Class I Construction (grounded)	no no load speed
 Class II Construction (double insulated)	⊕ earthing terminal
.../min per minute	⚠ safety alert symbol
IPM impacts per minute	BPM beats per minute
		RPM revolutions per minute

Important Safety Instructions for All Battery Packs

When ordering replacement battery packs, be sure to include catalog number and voltage. Consult the chart at the end of this manual for compatibility of chargers and battery packs.

The battery pack is not fully charged out of the carton. Before using the battery pack and charger, read the safety instructions below. Then follow charging procedures outlined.

READ ALL INSTRUCTIONS

- **Do not charge or use battery in explosive atmospheres, such as in the presence of flammable liquids, gases or dust.** Inserting or removing the battery from the charger may ignite the dust or fumes.
- **Never force battery pack into charger. Do not modify battery pack in any way to fit into a non-compatible charger as battery pack may rupture causing serious personal injury.** Consult the chart at the end of this manual for compatibility of batteries and chargers.
- Charge the battery packs only in DEWALT chargers.
- **DO NOT** splash or immerse in water or other liquids.
- **Do not store or use the tool and battery pack in locations where the temperature may reach or exceed 40°C (105°F) (such as outside sheds or metal buildings in summer).**

⚠ WARNING: Fire hazard. Never attempt to open the battery pack for any reason. If battery pack case is cracked or damaged, do not insert into charger. Do not crush, drop or damage battery pack. Do not use a battery pack or charger that has received

a sharp blow, been dropped, run over or damaged in any way (i.e., pierced with a nail, hit with a hammer, stepped on). Damaged battery packs should be returned to service center for recycling.

⚠ WARNING: Fire hazard. Do not store or carry battery so that metal objects can contact exposed battery terminals. For example, do not place battery in aprons, pockets, tool boxes, product kit boxes, drawers, etc., with loose nails, screws, keys, etc. **Transporting batteries can possibly cause fires if the battery terminals inadvertently come in contact with conductive materials such as keys, coins, hand tools and the like.** The US Department of Transportation Hazardous Material Regulations (HMR) actually prohibit transporting batteries in commerce or on airplanes (i.e., packed in suitcases and carry-on luggage) UNLESS they are properly protected from short circuits. So when transporting individual batteries, make sure that the battery terminals are protected and well insulated from materials that could contact them and cause a short circuit.

SPECIFIC SAFETY INSTRUCTIONS FOR LITHIUM ION (LI-ION)

- **Do not incinerate the battery pack even if it is severely damaged or is completely worn out.** The battery pack can explode in a fire. Toxic fumes and materials are created when lithium ion battery packs are burned.
- **If battery contents come into contact with the skin, immediately wash area with mild soap and water.** If battery liquid gets into the eye, rinse water over the open eye for 15 minutes or until irritation ceases. If medical attention is needed, the battery electrolyte is composed of a mixture of liquid organic carbonates and lithium salts.
- **Contents of opened battery cells may cause respiratory irritation.** Provide fresh air. If symptoms persists, seek medical attention.

⚠ WARNING: Burn hazard. Battery liquid may be flammable if exposed to spark or flame.

Important Safety Instructions for All Battery Chargers

SAVE THESE INSTRUCTIONS: This manual contains important safety and operating instructions for battery chargers.

- Before using charger, read all instructions and cautionary markings on charger, battery pack, and product using battery pack.

⚠ WARNING: Shock hazard. Do not allow any liquid to get inside charger. Electric shock may result.

⚠ CAUTION: Burn hazard. To reduce the risk of injury, charge only DEWALT rechargeable batteries. Other types of batteries may burst causing personal injury and damage.

NOTICE: Under certain conditions, with the charger plugged in to the power supply, the charger can be shorted by foreign material. Foreign materials of a conductive nature such as, but not limited to, grinding dust, metal chips, steel wool, aluminum foil, or any buildup of metallic particles should be kept away from charger cavities. Always unplug the charger from the power supply when there is no battery pack in the cavity. Unplug charger before attempting to clean.

- **DO NOT attempt to charge the battery pack with any chargers other than the ones in this manual.** The charger and battery pack are specifically designed to work together.
- **These chargers are not intended for any uses other than charging DEWALT rechargeable batteries.** Any other uses may result in risk of fire, electric shock or electrocution.
- **Do not expose charger to rain or snow.**
- **Pull by plug rather than cord when disconnecting charger.** This will reduce risk of damage to electric plug and cord.
- **Make sure that cord is located so that it will not be stepped on, tripped over, or otherwise subjected to damage or stress.**
- **Do not use an extension cord unless it is absolutely necessary.** Use of improper extension cord could result in risk of fire, electric shock, or electrocution.
- **When operating a power tool outdoors, use an extension cord suitable for outdoor use.** Use of a cord suitable for outdoor use reduces the risk of electric shock.
- **Do not place any object on top of charger or place the charger on a soft surface that might block the ventilation slots and result in excessive internal heat.** Place the charger in a position away from any heat source. The charger is ventilated through slots in the top and the bottom of the housing.
- **Do not operate charger with damaged cord or plug.**
- Do not operate charger if it has received a sharp blow, been dropped, or otherwise damaged in any way. Take it to an authorized service center.

- **Do not disassemble charger; take it to an authorized service center when service or repair is required.** Incorrect reassembly may result in a risk of electric shock, electrocution or fire.
- **Disconnect the charger from the outlet before attempting any cleaning. This will reduce the risk of electric shock.** Removing the battery pack will not reduce this risk.
- **NEVER** attempt to connect 2 chargers together.
- **The charger is designed to operate on standard 230 V household electrical power. Do not attempt to use it on any other voltage.** This does not apply to the vehicular charger.

Chargers

Your tool uses a DEWALT charger. Be sure to read all safety instructions before using your charger. Consult the chart on the back cover of this manual for compatibility of chargers and battery packs.

Charging Procedure (Fig. 1)

1. Plug the charger into an appropriate outlet before inserting battery pack.
2. Insert the battery pack (A) into the charger, as shown in Figure 1, making sure the pack is fully seated in charger. The red (charging) light will blink continuously indicating that the charging process has started.
3. The completion of charge will be indicated by the red light remaining ON continuously. The pack is fully charged and may be used at this time or left in the charger.

FIG. 1

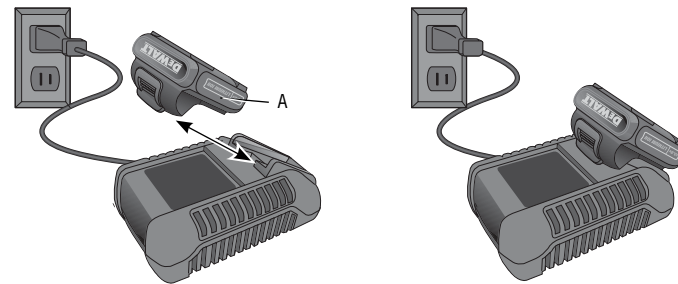

Storage Recommendations

1. The best storage place is one that is cool and dry away from direct sunlight and excess heat or cold.
2. Long storage will not harm the battery pack or charger. Under proper conditions, they can be stored for 5 years or more.

SAVE THESE INSTRUCTIONS FOR FUTURE USE

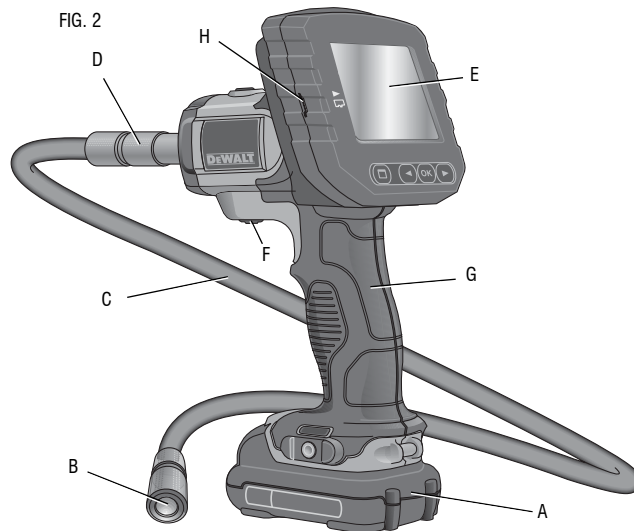

COMPONENTS (Fig. 2, 3)

⚠WARNING: Never modify the tool or any part of it. Damage or personal injury could result.

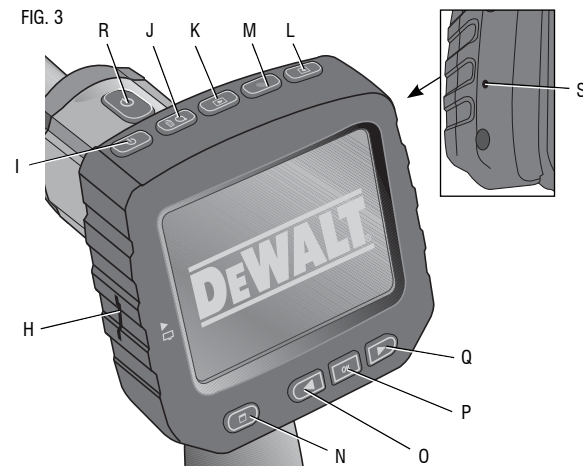

- A. 10.8V Max* Lithium Ion Battery
- B. Camera with LED's
- C. 0.9 m (3') Camera cable
- D. Camera connector
- E. Screen
- F. Camera cable on/off switch / LED brightness control switch
- G. Handle set











- H. Micro SD slot for micro SD memory cards 16 gb or less
- I.  **Power button for the screen:** Both the screen and the camera cable (F) need to be turned on.
- J.  **Zoom/Delete button:**

The button has 2 functions:

Zoom: This is to be used when you need a closer look at the object (3x zoom).

Delete: When in the folder menu, pictures can be deleted by using this button.

- K.  **Play:** Press the button to go to the folder where photos and videos are saved.
OR
Press the button to play videos.
- L.  **Camera:** Press this button for taking a photo.
- M.  **Record:** Press this button to start and stop recording a video.
- N.  **Main Menu:** Press this button to show a list of options for operating the inspection camera or to exit a screen.
- O.  **Back Arrow:** Press this button to navigate backward.
- P.  **OK:** Press this button to save changes.
- Q.  **Forward Arrow:** Press this button to navigate forward.
- R.  **Power indicator for the handle set:** When the green light is on it indicates that the handle set is on.
- S. Reset button

INTENDED USE

The inspection camera is designed to play real-time video while looking into walls and/or tight spaces. With a micro SD card (sold separately), the tool can then take photos or record videos for documentation purposes.

Photos are saved in JPG format and videos are saved as AVI. This DEWALT inspection camera is compatible with micro SD memory cards up to 16 gigabytes.

Applications consist of automotive inspection, plumbing inspection, HVAC inspection or cable routing. Read the entire manual before using this inspection camera.

DO NOT use in presence of flammable liquids or gases. The camera cable extension is waterproof up to the camera connector. **DO NOT USE** the handle set under wet conditions.

The inspection camera is a professional tool. **DO NOT** let children come into contact with the tool. Supervision is required when inexperienced operators use this tool.

ASSEMBLY

Screen (Fig. 4)

When the screen is attached to the handle set with a battery, it will receive a charge from the battery. Ensure the screen is fully charged before use.

When the screen is disengaged from the handle set, a battery icon appears in the upper left corner. This icon also displays the current charge of the screen.

To install the screen (E) into the handle set (G), align the screen with the rails on the handle set and slide it firmly into the handle until you hear the lock snap into place.

To remove the screen from the handle set, firmly slide the screen up from the tool handle.

The screen can be turned on and viewed when it is not attached to the handle set, allowing easier maneuverability of the camera.

FIG. 4

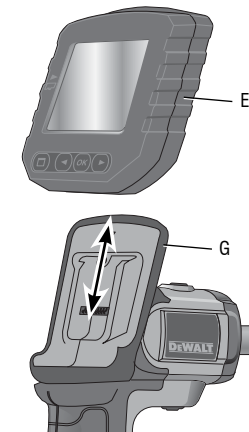

Camera Cable (Fig. 5)

Align the camera cable with the camera connector (D). Push in and turn the connector counterclockwise (camera screen facing you) to firmly attach.

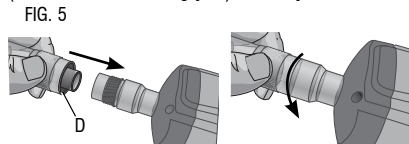

FIG. 5

To remove the camera cable, turn the connector clockwise (direction of arrow).

Additional camera cable and extensions are available at additional cost. Please contact Stanley Black & Decker, 82 Taryn Drive, Epping, VIC 3076 Australia or call 1800 444 224 or (NZ). 0800 339 258.

Hook and Magnet (Fig. 6)

The hook is beneficial for retrieving cable or wire located in tight spaces. The magnet is beneficial for retrieving metal objects in tight spaces.

To attach the hook or magnet, turn the knurled part of the camera counterclockwise until it stops.

Align the hook or magnet with the gray groove (T) then slide it down until the tabs (U) at the top of the hook/magnet are securely in the notches (V) located in the camera lens.

Turn the knurled part clockwise to lock the base of the hook and magnet.

FIG. 6A

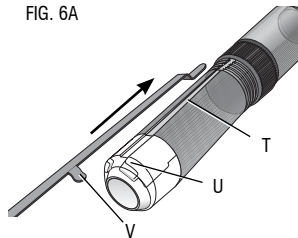
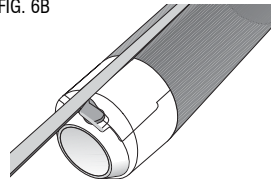

FIG. 6B



Belt Hook (Fig. 7) (Optional Accessory)

⚠ WARNING: To reduce the risk of serious personal injury, **DO NOT** suspend tool overhead or suspend objects from the belt hook. **ONLY** hang tool's belt hook from a work belt.

⚠ WARNING: To reduce the risk of serious personal injury, ensure the screw (W) holding the belt hook is secure.

IMPORTANT: When attaching or removing the belt hook, use only the screw (W) that is provided.

The belt hook (X) can be attached to either side of the tool using only the screw (W) provided, to accommodate left- or right- handed users. If the hook is not desired at all, it can be removed from the tool.

To move belt hook, remove the screw (W) that holds the belt hook in place then reassemble on the opposite side.

FIG. 7

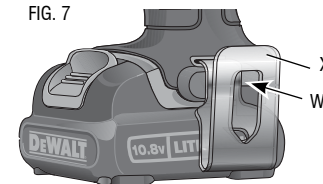

OPERATION

Installing and Removing the Battery Pack (Fig. 8)

NOTE: Make sure your battery pack is fully charged.

To install the battery pack (A) into the tool handle, align the battery with the rails inside the tool's handle and slide it firmly into the handle until you hear the lock snap into place.

FIG. 8

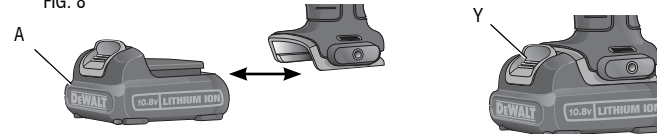

To remove the battery pack from the tool, press the release button (Y) and firmly pull the battery pack out of the tool handle. Insert it into the charger as described in the charger section of this manual.

Getting Started

INITIAL SETUP

Language Setup

1. Press the forward or back arrow to select English.



2. Press the OK button to confirm and exit.

Date and Time Setup

1. Press the forward or back arrow to highlight the field to change.

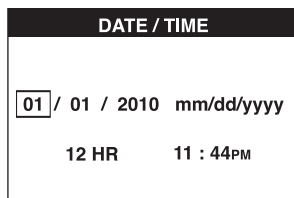

2. Press the OK button to activate the field (field turns green).
3. Press the forward or back arrow to change the activated field.
4. Press the OK button to save changes (field turns yellow).
5. Repeat above steps to change remaining fields.
6. Press the main menu button to exit.

BASIC OPERATION

NOTE: At any time during the camera operation, pressing the main menu button will return to the previous menu.

To Record Photos or Videos

Be sure a micro SD card (sold separately) is loaded in the card slot (H).

1. Turn both the camera (B) and the handle set (G) on.
2. Aim camera at destination.

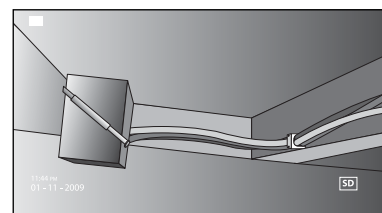

- A. Press the camera button (L) to take a photo. A confirmation icon will appear in the top right side of screen.

OR

- B. Press the record button (M) to start recording.

A red dot will appear in the top right side of the screen. To stop recording, press the record button again.

The camera will create a folder on the micro SD card for that day. All photos or videos taken that day will be stored in this folder.

To View Photos or Videos

1. Press the main menu button to show the Main Menu.

2. Press the forward or back arrow to select the Folder option.

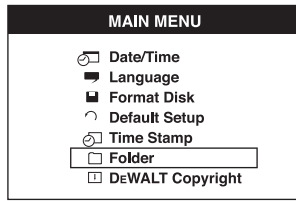

3. Press the OK button to navigate to the next screen.

4. Press the forward or back arrow to select a dated folder.

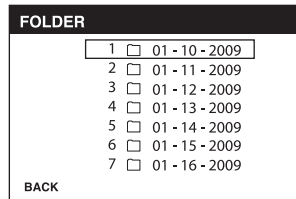

5. Press the OK button to select the dated folder.

6. Press the forward or back arrow to select the photo or video.

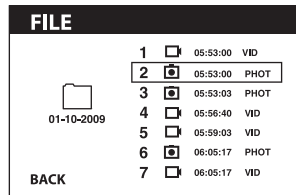

7. Press the OK button to view the photo or video.

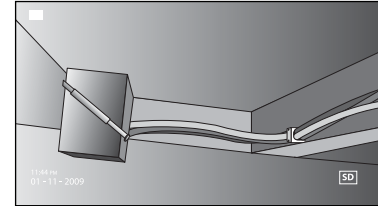

8. Press the forward or back arrow to advance to the next photo or video.

9. When finished, press the main menu button to exit.

To Delete Individual Photos or Videos:

1. Press the main menu button to show the Main Menu.

2. Press the forward or back arrow to select the Folder option.

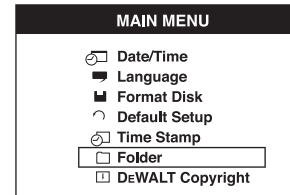

3. Press the OK button to navigate to the next screen.

4. Press the forward or back arrow to select a dated folder.

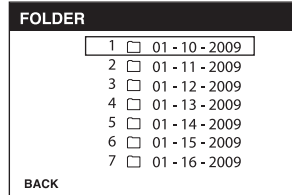

5. Press the OK button to navigate to the next screen.

6. Press the forward or back arrow to select a photo or video.

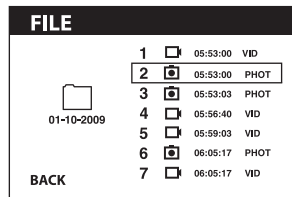

7. Press the delete button. Select YES to delete the individual photo or video.

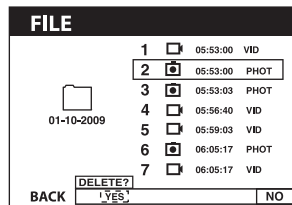

8. Press the main menu button to exit.

To Delete a Photo or Video While Viewing

1. Press the main menu button to show the Main Menu.

2. Press the forward or back arrow to select the Folder option.

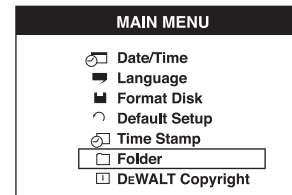

3. Press the OK button to navigate to the next screen.

4. Press the forward or back arrow to select a dated folder.

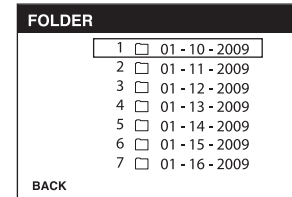

5. Press the OK button to navigate to the next screen.

6. Press the forward or back arrow to select a photo or video.

7. Press the OK button to view.

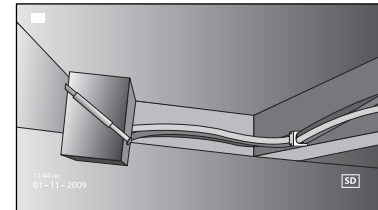

- Press the delete button. Select YES to delete the individual photo or video.

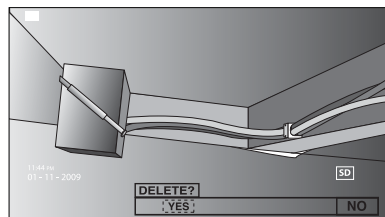

To Change Languages

- Press the main menu button to show the Main Menu.
- Press the forward or back arrow to select the Language option.

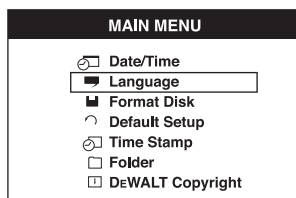

- Press the OK button to select.
- Press the forward or back arrow to select English.



- Press the OK button to save changes.

- Press the main menu button to exit.

To Change Date/Time

- Press the main menu button to show the Main Menu.
- Press the forward or back arrow to select Date/Time option.

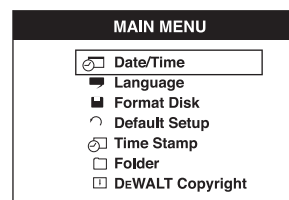

- Press the OK button to navigate to the next screen.
- Press the forward or back arrow to highlight a field to change.

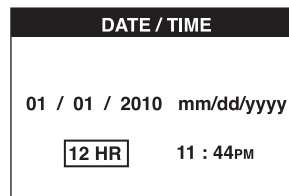

- Press the OK button to activate the field (field turns green).
- Press the forward or back arrow to change the activated field.
- Press the OK button to save changes.
- Repeat above steps to change remaining fields.
- Press the main menu button to exit.

To Activate the Time Stamp

1. Press the main menu button to show the Main Menu.
2. Press the forward or back arrow to select the Time Stamp option.

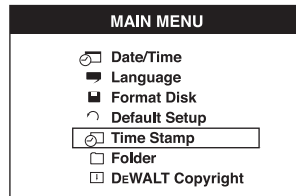

3. Press the OK button to navigate to the next screen.
4. Press the forward or back arrow to select OFF or ON.

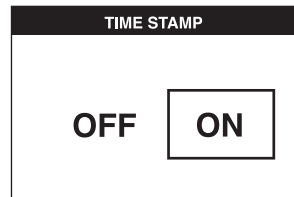
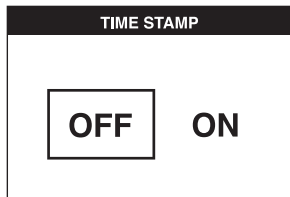

5. Press the OK button to save changes.
6. Press the main menu button to exit.

To Format Micro SD Card

NOTICE: Formatting the micro SD card will erase all data.

1. Press the main menu button to show the Main Menu.

2. Press the forward or back arrow to select the Format Disk option.

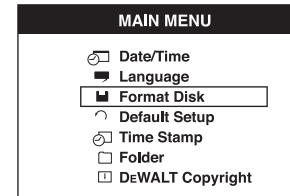

3. Press the OK button to navigate to the next screen.
4. Press the forward or back arrow to select NO or YES.

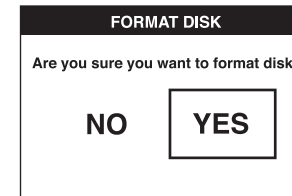
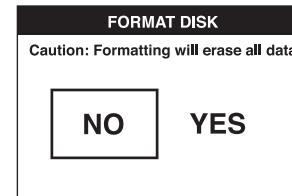

5. Press the OK button to save changes and exit.

To Change Default Setup

NOTICE: Changing to default setup will erase current settings and restore factory settings.

1. Press the main menu button to show the Main Menu.

2. Press the forward or back arrow to select the Default Setup option.

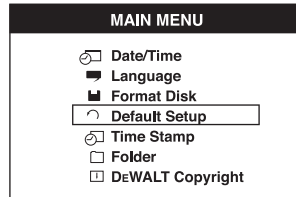

3. Press the OK button to navigate to the next screen.

4. Press the forward or back arrow to select NO or YES.

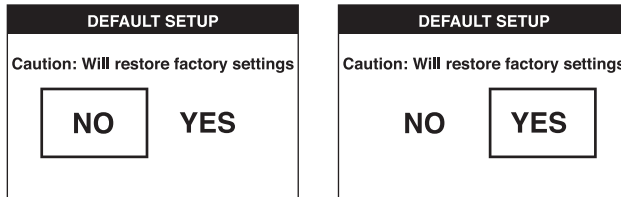

5. Press the OK button to save changes and exit.

Operating Tips

- Use only DeWALT 10.8V lithium ion battery.
- Ensure the DeWALT battery is in good working condition. If the low battery indicator light on the screen is flashing, the battery needs to be recharged.
- To extend battery life, make sure to turn both the screen and the handle set off when not in use.
- Make sure the screen is fully charged before operation.

MAINTENANCE

Cleaning

⚠WARNING: Blow dirt and dust out of all air vents with clean, dry air at least once a week. To minimize the risk of eye injury, always wear AS/NZS51337 approved eye protection when performing this.

⚠WARNING: Never use solvents or other harsh chemicals for cleaning the non-metallic parts of the tool. These chemicals may weaken the plastic materials used in these parts. Use a cloth dampened only with water and mild soap. Never let any liquid get inside the tool; never immerse any part of the tool into a liquid.

CHARGER CLEANING INSTRUCTIONS

⚠WARNING: Shock hazard. Disconnect the charger from the AC outlet before cleaning. Dirt and grease may be removed from the exterior of the charger using a cloth or soft non-metallic brush. Do not use water or any cleaning solutions.

Troubleshooting

- Make sure the 10.8V battery is charged.
- Make sure the screen is fully charged.
- Make sure the screen is always attached to the handle set. The picture may freeze if you attempt to remove the (screen) from the handle set while taking a photo or video.
- Make sure the battery is installed on the handle set when in use.
- Make sure the camera cable is attached to the handle set properly.
- Make sure the handle set is turned on as well as the screen.
- Make sure the back of the handle set is not covered with debris so the screen slides on easily and no damage to the screen occurs.
- If the screen freezes or won't turn on, insert a small object (i.e., paper clip end) into the reset button located on the back of the screen.
- If the picture is dim, roll the brightness control switch to brighten the LED light.

Repairs

The charger is not serviceable. There are no serviceable parts inside the charger. To assure product SAFETY and RELIABILITY, repairs, maintenance and adjustment (including brush inspection and replacement) should be performed by certified service centers or other qualified service organizations, always using identical replacement parts.

ACCESSORIES

⚠ WARNING: Since accessories, other than those offered by DEWALT, have not been tested with this product, use of such accessories with this tool could be hazardous. To reduce the risk of injury, only DEWALT, recommended accessories should be used with this product.

Recommended accessories for use with your tool are available at extra cost from your local service center. If you need any assistance in locating any accessory, please contact Stanley Black & Decker, 82 Taryn Drive, Epping, VIC 3076 Australia or call 1800 444 224 or (NZ). 0800 339 258.

RECOMMENDED ACCESSORIES

- Camera cable: 17mm diameter
- Camera cable: 9mm diameter
- 0.9 m (3') cable extension: 17mm diameter
- Hook and magnet

SPECIFICATIONS

Camera Cable Diameter	DCT410-XE: 17 mm DCT411-XE: 9 mm
Cable length	0.9 m (3')
Resolution	320 x 480 dpi
Screen Size	88.9 mm (3.5")



DeWALT BATTERY AND CHARGER SYSTEMS																						
Battery		Chargers/Charge Time																				
Cat. Number	Voltage	Output Nominal	Amp Hour	240 Volts																	12 Volts	
				97014	98014	DW9106	DW9107	DW9108	DW9115	DW9116	DW9117	DW9118	DE9116	DE9118	DW911	DC011	DW0245	DE2046	DE9000	DC9310	DCB100	DW9109
DC9360	36	2.2	X	X	X	X	X	X	X	X	X	X	X	X	X	X	X	60	X	X	X	X
DE0240-XJ	24	2.0	X	X	X	X	X	X	X	X	X	X	X	X	X	60	60	X	X	X	X	X
DW0242	24	2.0	X	X	X	X	X	X	X	X	X	X	X	X	60	60	X	X	X	X	X	X
DW0240	24	1.7	X	X	X	X	X	X	X	X	X	X	X	X	60	60	X	X	X	X	X	X
DC9096	18	2.4	X	X	X	X	60	X	60	20	X	60	X	60	60	X	X	X	60	X	60	60
DC9180	18	2.0	X	X	X	X	X	X	X	X	X	X	X	X	X	X	X	X	60	X	X	60
DW9096	18	2.4	X	X	X	X	60	X	60	20	X	60	X	60	60	X	X	X	60	X	60	60
DE9095-XJ	18	2.0	X	X	X	X	60	X	60	20	X	60	X	60	60	X	X	X	60	X	60	60
DC9091	14.4	2.4	60	60	60	60	15	60	15	60	60	60	60	60	X	X	X	60	X	60	60	
DC9144	14.4	2.0	X	X	X	X	X	X	X	X	X	X	X	X	X	X	X	X	60	X	X	60
DE9094	14.4	1.3	45	45	45	30	30	15	30	12	60	30	60	30	X	X	X	X	30	X	30	30
DE9091-XJ	14.4	2.0	45	45	45	45	45	15	45	15	90	45	90	45	45	X	X	X	45	X	45	45
DW9091	14.4	1.7	45	45	45	45	45	15	45	15	90	45	90	45	45	X	X	X	45	X	45	45
DC9071	12	2.4	60	60	60	60	60	15	60	15	60	60	60	60	X	X	X	60	X	60	60	
DE9071-XJ	12	2.0	60	60	60	45	45	15	45	15	90	45	90	45	45	X	X	X	45	X	45	45
DE9074-XJ	12	1.25	45	45	45	30	30	15	30	12	60	30	60	30	X	X	X	X	30	X	30	30
DW9050	12	1.3	40	40	40	X	X	15	X	X	X	X	X	X	X	X	X	X	X	X	X	X
DW9071	12	1.7	60	60	60	45	45	15	45	15	90	45	90	45	45	X	X	X	45	X	45	45
DW9072	12	1.2	45	45	45	30	30	15	30	12	60	30	60	30	X	X	X	X	30	X	30	30
DCB120	10.8	X	X	X	X	X	X	X	X	X	X	X	X	X	X	X	X	X	X	40	X	X
DW9063	9.6	1.25	45	45	45	30	30	15	30	12	60	30	60	30	30	X	X	X	30	X	30	30
DW9062	9.6	1.3	45	45	45	30	30	15	30	12	60	30	60	30	30	X	X	X	30	X	30	30
DW9061	9.6	1.7	60	60	60	45	45	15	45	15	90	45	90	45	45	X	X	X	45	X	45	45
DW9048	9.6	1.3	40	40	40	X	X	15	X	X	X	X	X	X	X	X	X	X	X	X	X	X
DW9057	7.2	1.25	45	45	45	30	30	15	30	12	60	30	60	30	30	X	X	X	30	X	30	30
DW9046	7.2	1.3	40	40	40	X	X	15	X	X	X	X	X	X	X	X	X	X	X	X	X	X

X Indicates that the battery pack is not compatible with that specific charger.
 All charge times are approximate. Actual charge time may vary.
 Read the instruction manual for more specific information.
 The battery voltage is nominal, it can measure above or below depending on the state of charge.

Stanley Black & Decker
 701 East Joppa Road, Baltimore, MD 21286 • 82 Taryn Drive, Epping, VIC 3076 Australia
 (APR11) Part No. N081720 DCT410-XE Copyright © 2011 DeWALT

The following are trademarks for one or more DeWALT power tools: the yellow and black color scheme; the "D" shaped air intake grill; the array of pyramids on the handgrip; the kit box configuration; and the array of lozenge-shaped humps on the surface of the tool.