

INSTRUCTION MANUAL

DEWALT®

DCD960-XE, DCD980-XE

HEAVY-DUTY 13 mm (1/2") CORDLESS DRILL/DRIVER

DCD950-XE, DCD970-XE, DCD990-XE

HEAVY-DUTY 13 mm (1/2") CORDLESS HAMMERDRILL/DRILL/DRIVERS

Definitions: Safety Guidelines

The definitions below describe the level of severity for each signal word. Please read the manual and pay attention to these symbols.

⚠DANGER: Indicates an imminently hazardous situation which, if not avoided, **will** result in **death or serious injury**.

⚠WARNING: Indicates a potentially hazardous situation which, if not avoided, **could** result in **death or serious injury**.

⚠CAUTION: Indicates a potentially hazardous situation which, if not avoided, **may** result in **minor or moderate injury**.

CAUTION: Used without the safety alert symbol indicates a potentially hazardous situation which, if not avoided, **may** result in **property damage**.

IF YOU HAVE ANY QUESTIONS OR COMMENTS ABOUT THIS OR ANY DEWALT TOOL, CALL US AT: **1800 654 155** (Aust) or **0800 339258** (NZ).

SAFETY INSTRUCTIONS FOR POWER TOOLS

When using power tools, always observe the safety regulations applicable in your country to reduce the risk of fire, electric shock and personal injury. Read the following safety instructions before attempting to operate this product. Keep these instructions in a safe place.



WARNING: To reduce the risk of injury, read the instruction manual.

GENERAL SAFETY WARNINGS



WARNING! Read all safety warnings and all instructions. Failure to follow the warnings and instructions may result in electric shock, fire and/or serious injury.

The term "power tool" in the warnings refers to your mains-operated (corded) power tool or battery-operated (cordless) power tool.

SAVE THESE INSTRUCTIONS

1) WORK AREA SAFETY

- a) **Keep work area clean and well lit.** Cluttered or dark areas invite accidents.
- b) **Do not operate power tools in explosive atmospheres, such as in the presence of flammable liquids, gases or dust.** Power tools create sparks which may ignite the dust or fumes.
- c) **Keep children and bystanders away while operating a power tool.** Distractions can cause you to lose control.

2) ELECTRICAL SAFETY

- a) **Power tool plugs must match the outlet. Never modify the plug in any way. Do not use any adapter plugs with earthed (grounded) power tools.** Unmodified plugs and matching outlets will reduce risk of electric shock.
- b) **Avoid body contact with earthed or grounded surfaces such as pipes, radiators, ranges and refrigerators.** There is an increased risk of electric shock if your body is earthed or grounded.
- c) **Do not expose power tools to rain or wet conditions.** Water entering a power tool will increase the risk of electric shock.
- d) **Do not abuse the cord. Never use the cord for carrying, pulling or unplugging the power tool. Keep cord away from heat, oil, sharp edges or moving parts.** Damaged or entangled cords increase the risk of electric shock.
- e) **When operating a power tool outdoors, use an extension cord suitable for outdoor use.** Use of a cord suitable for outdoor use reduces the risk of electric shock.

3) PERSONAL SAFETY

- a) **Stay alert, watch what you are doing and use common sense when operating a power tool. Do not use a power tool while you are tired or under the influence of drugs, alcohol or medication.** A moment of inattention while operating power tools may result in serious personal injury.
- b) **Use safety equipment. Always wear eye protection.** Protective equipment such as dust mask, non-skid safety shoes, hard hat, or hearing protection used for appropriate conditions will reduce personal injuries.

- c) **Prevent unintentional starting. Ensure the switch is in the off position before plugging in.** Carrying power tools with your finger on the switch or plugging in power tools that have the switch on invites accidents.
- d) **Remove any adjusting key or wrench before turning the power tool on.** A wrench or a key left attached to a rotating part of the power tool may result in personal injury.
- e) **Do not overreach. Keep proper footing and balance at all times.** This enables better control of the power tool in unexpected situations.
- f) **Dress properly. Do not wear loose clothing or jewellery. Keep your hair, clothing and gloves away from moving parts.** Loose clothes, jewellery or long hair can be caught in moving parts.
- g) **If devices are provided for the connection of dust extraction and collection facilities, ensure these are connected and properly used.** Use of dust collection can reduce dust-related hazards.

4) POWER TOOL USE AND CARE

- a) **Do not force the power tool. Use the correct power tool for your application.** The correct power tool will do the job better and safer at the rate for which it was designed.
- b) **Do not use the power tool if the switch does not turn it on and off.** Any power tool that cannot be controlled with the switch is dangerous and must be repaired.
- c) **Disconnect the plug from the power source and/or the battery pack from the power tool before making any adjustments, changing accessories, or storing power tools.** Such preventive safety measures reduce the risk of starting the power tool accidentally.
- d) **Store idle power tools out of the reach of children and do not allow persons unfamiliar with the power tool or these instructions to operate the power tool.** Power tools are dangerous in the hands of untrained users.
- e) **Maintain power tools. Check for misalignment or binding of moving parts, breakage of parts and any other condition that may affect the power tool's operation. If damaged, have the power tool repaired before use.** Many accidents are caused by poorly maintained power tools.
- f) **Keep cutting tools sharp and clean.** Properly maintained cutting tools with sharp cutting edges are less likely to bind and are easier to control.

- g) **Use the power tool, accessories and tool bits etc., in accordance with these instructions and in the manner intended for the particular type of power tool, taking into account the working conditions and the work to be performed.** Use of the power tool for operations different from those intended could result in a hazardous situation..

5) BATTERY TOOL USE AND CARE

- a) **Ensure the switch is in the off position before inserting battery pack.** Inserting the battery pack into power tools that have the switch on invites accidents
- b) **Recharge only with the charger specified by the manufacturer.** A charger that is suitable for one type of battery pack may create a risk of fire when used with another battery pack.
- c) **Use power tools only with specifically designated battery packs.** Use of any other battery packs may create a risk of injury and fire.
- d) **When battery pack is not in use, keep it away from other metal objects like paper clips, coins, keys, nails, screws, or other small metal objects that can make a connection from one terminal to another.** Shorting the battery terminals together may cause burns or a fire.
- e) **Under abusive conditions, liquid may be ejected from the battery, avoid contact. If contact accidentally occurs, flush with water. If liquid contacts eyes, additionally seek medical help.** Liquid ejected from the battery may cause irritation or burns.

6) SERVICE

- a) **Have your power tool serviced by a qualified repair person using only identical replacement parts.** This will ensure that the safety of the power tool is maintained.

Electrical Safety

The electric motor has been designed for one voltage only. Always check that the power supply corresponds to the voltage on the rating plate. 230 V AC means your tool will operate on alternating current. As little as 10% lower voltage can cause loss of power and can result in overheating. All DeWALT tools are factory tested; if this tool does not operate, check the power supply. Your DeWALT tool is double insulated, therefore no earth wire is required.

- **Young children and the infirm.** This appliance is not intended for use by young children or infirm persons without supervision. Young children should be supervised to ensure that they do not play with this appliance.
- **Replacement of the supply cord.** If the supply cord is damaged, it must be replaced by the manufacturer or an authorised DeWALT Service Centre in order to avoid a hazard.

Extension Cords

⚠ CAUTION: Use only extension cords that are approved by the country's Electrical Authority. Before using extension cords, inspect them for loose or exposed wires, damaged insulation and defective fittings. Replace the cord if necessary.

MINIMUM GAUGE FOR CORD SETS

For Cable length (m):	7.5	15	25	30	45	60
Use Cable with minimum rating (Amperes)						
Tool Amperes						
0 - 3.4	7.5	7.5	7.5	7.5	7.5	7.5
3.5 - 5.0	7.5	7.5	7.5	7.5	10	15
5.1 - 7.0	10	10	10	10	15	15
7.1 - 12.0	15	15	15	15	20	20
12.1 - 20.0	20	20	20	20	25	—

Safety Warnings for Hammerdrills/Drills/Drivers

- **Wear ear protectors with impact drills.** Exposure to noise can cause hearing loss.
 - **Use auxiliary handles supplied with the tool.** Loss of control can cause personal injury.
 - **Hold power tools by insulated gripping surfaces when performing an operation where the cutting tool may contact hidden wiring or its own cord.** Contact with a "live" wire will make exposed metal parts of the tool "live" and shock the operator.
 - **Use clamps or another practical way to secure and support the workpiece to a stable platform.** Holding the work by hand or against your body leaves it unstable and may lead to loss of control.
 - **Wear ear protectors when hammering for extended periods of time.** Prolonged exposure to high intensity noise can cause hearing loss. Temporary hearing loss or serious ear drum damage may result from high sound levels generated by hammer drilling.
 - **Wear safety goggles or other eye protection.** Hammering and drilling operations cause chips to fly. Flying particles can cause permanent eye damage. Wear a dust mask or respirator for applications that generate dust. Ear protection may be required for most applications.
 - **Always use the side handle supplied with the tool. Keep a firm grip on the tool at all times. Do not attempt to operate this tool without holding it with both hands.** Operating this tool with one hand will result in loss of control. Breaking through or encountering hard materials such as re-bar may be hazardous as well.
 - **Accessories and tool may get hot during operation.** Wear gloves when handling them if performing heat producing applications such as hammerdrilling and drilling metals.
 - **Do not operate this tool for long periods of time.** Vibration caused by hammer action may be harmful to your hands and arms. Use gloves to provide extra cushion and limit exposure by taking frequent rest periods.
 - **Air vents often cover moving parts and should be avoided.** Loose clothes, jewellery or long hair can be caught in moving parts
- ⚠ WARNING: ALWAYS** use safety glasses. Everyday eyeglasses are NOT safety glasses. Also use face or dust mask if cutting operation is dusty. **ALWAYS WEAR CERTIFIED SAFETY EQUIPMENT:**
- ANSI Z87.1 eye protection (CAN/CSA Z94.3),
 - ANSI S12.6 (S3.19) hearing protection,
 - NIOSH/OSHA/MSHA respiratory protection.
- ⚠ WARNING:** Some dust created by power sanding, sawing, grinding, drilling, and other construction activities contains chemicals known to cause cancer, birth defects or other reproductive harm. Some examples of these chemicals are:
- lead from lead-based paints,
 - crystalline silica from bricks and cement and other masonry products, and
 - arsenic and chromium from chemically-treated lumber (CCA).

Your risk from these exposures varies, depending on how often you do this type of work. To reduce your exposure to these chemicals: work in a well ventilated area, and work with approved safety equipment, such as those dust masks that are specially designed to filter out microscopic particles.

- **Avoid prolonged contact with dust from power sanding, sawing, grinding, drilling, and other construction activities. Wear protective clothing and wash exposed areas with soap and water.** Allowing dust to get into your mouth, eyes, or lay on the skin may promote absorption of harmful chemicals.

⚠ WARNING: Use of this tool can generate and/or disburse dust, which may cause serious and permanent respiratory or other injury. Always use NIOSH/OSHA approved respiratory protection appropriate for the dust exposure. Direct particles away from face and body.

⚠ WARNING: ALWAYS wear proper personal hearing protection that conforms to ANSI S12.6 (S3.19) during use. Under some conditions and duration of use, noise from this product may contribute to hearing loss.

⚠ WARNING: Always use eye protection. All users and bystanders must wear eye protection that conforms to ANSI Z87.1.

⚠ CAUTION: When not in use, place tool on its side on a stable surface where it will not cause a tripping or falling hazard. Some tools with large battery packs will stand upright on the battery pack but may be easily knocked over.

- The label on your tool may include the following symbols. The symbols and their definitions are as follows:

V	volts	A	amperes
Hz	hertz	W	watts
min	minutes	~	alternating current
==	direct current	⎓	alternating or direct current
Ⓜ	Class I Construction (grounded)	n _o	no load speed
□	Class II Construction (double insulated)	⊕	earthing terminal
.../min	per minute	⚠	safety alert symbol
		BPM	beats per minute
		RPM	revolutions per minute

SAVE THESE INSTRUCTIONS FOR FUTURE USE

Residual Risks

- In spite of the application of the relevant safety regulations and the implementation of safety devices, certain residual risks cannot be avoided. These are:
 - Impairment of hearing.
 - Risk of personal injury due flying particles.
 - Risk of dust inhalation.
 - Risk of personal injury due to prolonged use.
 - Risk of burns due to accessories becoming hot during operation.

Important Safety Instructions for All Battery Packs

Your tool uses DeWALT battery packs. When ordering replacement battery packs, be sure to include catalog number and voltage. Consult the chart at the end of this manual for compatibility of chargers and battery packs.

The battery pack is not fully charged out of the carton. Before using the battery pack and charger, read the safety instructions below. Then follow charging procedures outlined.

READ ALL INSTRUCTIONS

- **Do not charge or use battery in explosive atmospheres, such as in the presence of flammable liquids, gases or dust.** Inserting or removing the battery from the charger may ignite the dust or fumes.
- **Never force battery pack into charger. Do not modify battery pack in any way to fit into a non-compatible charger as battery pack may rupture causing serious personal injury.** Consult the chart at the end of this manual for compatibility of batteries and chargers.
- Charge the battery packs only in DeWALT chargers.
- **DO NOT** splash or immerse in water or other liquids.
- **Do not store or use the tool and battery pack in locations where the temperature may reach or exceed 40 °C (105 °F) (such as outside sheds or metal buildings in summer).**

⚠ DANGER: Electrocutation hazard. Never attempt to open the battery pack for any reason. If battery pack case is cracked or damaged, do not insert into charger. Do not crush, drop or damage battery pack. Do not use a battery pack or charger that has

received a sharp blow, been dropped, run over or damaged in any way (i.e., pierced with a nail, hit with a hammer, stepped on). Electric shock or electrocution may result. Damaged battery packs should be returned to service center for recycling.

NOTE: Battery storage and carrying caps are provided for use whenever the battery is out of the tool or charger. Remove cap before placing battery in charger or tool.



▲ WARNING: Fire hazard. Do not store or carry battery so that metal objects can contact exposed battery terminals.

For example, do not place battery in aprons, pockets, tool boxes, product kit boxes, drawers, etc., with loose nails, screws, keys, etc. without battery cap. **Transporting batteries can possibly cause fires if the battery terminals inadvertently come in contact with conductive materials such as keys, coins, hand tools and the like.**

The US Department of Transportation Hazardous Material Regulations (HMR) actually prohibit transporting batteries in commerce or on airplanes (i.e., packed in suitcases and carry-on luggage) UNLESS they are properly protected from short circuits. So when transporting individual batteries, make sure that the battery terminals are protected and well insulated from materials that could contact them and cause a short circuit.

SPECIFIC SAFETY INSTRUCTIONS FOR NICKEL CADMIUM (NICD) OR NICKEL METAL HYDRIDE (NIMH)

- **Do not incinerate the battery pack even if it is severely damaged or is completely worn out.** The battery pack can explode in a fire.
- **A small leakage of liquid from the battery pack cells may occur under extreme usage or temperature conditions.** This does not indicate a failure.

However, if the outer seal is broken:

- a. and the battery liquid gets on your skin, immediately wash with soap and water for several minutes.
- b. and the battery liquid gets into your eyes, flush them with clean water for a minimum of 10 minutes and seek immediate medical attention. **(Medical note:** The liquid is 25-35% solution of potassium hydroxide.)

SPECIFIC SAFETY INSTRUCTIONS FOR LITHIUM ION (LI-ION)

- **Do not incinerate the battery pack even if it is severely damaged or is completely worn out.** The battery pack can explode in a fire. Toxic fumes and materials are created when lithium ion battery packs are burned.

- **If battery contents come into contact with the skin, immediately wash area with mild soap and water.** If battery liquid gets into the eye, rinse water over the open eye for 15 minutes or until irritation ceases. If medical attention is needed, the battery electrolyte is composed of a mixture of liquid organic carbonates and lithium salts.
- **Contents of opened battery cells may cause respiratory irritation.** Provide fresh air. If symptoms persists, seek medical attention.

▲ WARNING: Burn hazard. Battery liquid may be flammable if exposed to spark or flame.

The RBRC™ Seal

The RBRC™ (Rechargeable Battery Recycling Corporation) Seal on the nickel cadmium, nickel metal hydride or lithium ion batteries (or battery packs) indicate that the costs to recycle these batteries (or battery packs) at the end of their useful life have already been paid by DeWALT. In some areas, it is illegal to place spent nickel cadmium, nickel metal hydride or lithium ion batteries in the trash or municipal solid waste stream and the RBRC program provides an environmentally conscious alternative.



RBRC™ in cooperation with DeWALT and other battery users, has established programs in the United States and Canada to facilitate the collection of spent nickel cadmium, nickel metal hydride or lithium ion batteries. Help protect our environment and conserve natural resources by returning the spent nickel cadmium and nickel cadmium, nickel metal hydride or lithium ion batteries to an authorized DeWALT service center or to your local retailer for recycling. You may also contact your local recycling center for information on where to drop off the spent battery.

RBRC™ is a registered trademark of the *Rechargeable Battery Recycling Corporation*.

Important Safety Instructions for all Battery Chargers

SAVE THESE INSTRUCTIONS: This manual contains important safety and operating instructions for battery chargers.

- Before using charger, read all instructions and cautionary markings on charger, battery pack, and product using battery pack.

▲ DANGER: Electrocution hazard. 230 volts are present at charging terminals. Do not probe with conductive objects. Electric shock or electrocution may result.

▲ WARNING: Shock hazard. Do not allow any liquid to get inside charger. Electric shock may result.

⚠ CAUTION: Burn hazard. To reduce the risk of injury, charge only DeWALT rechargeable batteries. Other types of batteries may burst causing personal injury and damage.

⚠ CAUTION: Under certain conditions, with the charger plugged in to the power supply, the exposed charging contacts inside the charger can be shorted by foreign material. Foreign materials of a conductive nature such as, but not limited to, steel wool, aluminum foil, or any buildup of metallic particles should be kept away from charger cavities. Always unplug the charger from the power supply when there is no battery pack in the cavity. Unplug charger before attempting to clean.

- **DO NOT attempt to charge the battery pack with any chargers other than the ones in this manual.** The charger and battery pack are specifically designed to work together.
- **These chargers are not intended for any uses other than charging DeWALT rechargeable batteries.** Any other uses may result in risk of fire, electric shock or electrocution.
- **Do not expose charger to rain or snow.**
- **Pull by plug rather than cord when disconnecting charger.** This will reduce risk of damage to electric plug and cord.
- **Make sure that cord is located so that it will not be stepped on, tripped over, or otherwise subjected to damage or stress.**
- **Do not use an extension cord unless it is absolutely necessary.** Use of improper extension cord could result in risk of fire, electric shock, or electrocution.
- **When operating a power tool outdoors, use an extension cord suitable for outdoor use.** Use of a cord suitable for outdoor use reduces the risk of electric shock.
- **Do not place any object on top of charger or place the charger on a soft surface that might block the ventilation slots and result in excessive internal heat.** Place the charger in a position away from any heat source. The charger is ventilated through slots in the top and the bottom of the housing.
- **Do not operate charger with damaged cord or plug.**
- **Do not operate charger if it has received a sharp blow, been dropped, or otherwise damaged in any way.** Take it to an authorized service center.

- **Do not disassemble charger; take it to an authorized service center when service or repair is required.** Incorrect reassembly may result in a risk of electric shock, electrocution or fire.
- **Disconnect the charger from the outlet before attempting any cleaning. This will reduce the risk of electric shock.** Removing the battery pack will not reduce this risk.
- **NEVER** attempt to connect 2 chargers together.
- **The charger is designed to operate on standard 230V household electrical power. Do not attempt to use it on any other voltage.** This does not apply to the vehicular charger.
- **We recommend the use of a residual current device with a rated residual current of 30 mA or less.**

Using Automatic Tune-Up™ Mode

The automatic Tune-Up™ Mode equalizes or balances the individual cells in the battery pack allowing it to function at peak capacity. Battery packs should be tuned up weekly or after 10 charge/discharge cycles or whenever the pack no longer delivers the same amount of work. To use the automatic Tune-Up™, place the battery pack in the charger and leave it for at least 8 hours. The charger will cycle through the following modes.

1. The red light will blink continuously indicating that the 1-hour charge cycle has started.
2. When the 1-hour charge cycle is complete, the light will stay on continuously and will no longer blink. This indicates that the pack is fully charged and can be used at this time.
3. If the pack is left in the charger after the initial 1-hour charge, the charger will begin the Automatic Tune-Up mode. This mode continues up to 8 hours or until the individual cells in the battery pack are equalized. The battery pack is ready for use and can be removed at any time during the Tune-Up mode.
4. Once the Automatic Tune Up mode is complete, the charger will begin a maintenance charge; the red indicator will remain lit.

2. The charger and battery pack may become warm to touch while charging. This is a normal condition, and does not indicate a problem. To facilitate the cooling of the battery pack after use, avoid placing the charger or battery pack in a warm environment such as in a metal shed, or an uninsulated trailer.
3. If the battery pack does not charge properly:
 - a. Check current at receptacle by plugging in a lamp or other appliance
 - b. Check to see if receptacle is connected to a light switch which turns power off when you turn out the lights.
 - c. Move charger and battery pack to a location where the surrounding air temperature is approximately 18°- 24°C (65°F - 75°F).
 - d. If charging problems persist, take the tool, battery pack and charger to your local service center.
4. The battery pack should be recharged when it fails to produce sufficient power on jobs which were easily done previously. **DO NOT CONTINUE** to use under these conditions. Follow the charging procedure. You may also charge a partially used pack whenever you desire with no adverse affect on the battery pack.
5. Under certain conditions, with the charger plugged into the power supply, the exposed charging contacts inside the charger can be shorted by foreign material. Foreign materials of a conductive nature such as, but not limited to, steel wool, aluminum foil, or any buildup of metallic particles should be kept away from charger cavities. Always unplug the charger from the power supply when there is no battery pack in the cavity. Unplug charger before attempting to clean.
6. Do not freeze or immerse charger in water or any other liquid.

⚠ WARNING: Shock hazard. Don't allow any liquid to get inside charger. Electric shock may result.

⚠ CAUTION: Never attempt to open the battery pack for any reason. If the plastic housing of the battery pack breaks or cracks, return to a service center for recycling.

Storage Recommendations

1. The best storage place is one that is cool and dry away from direct sunlight and excess heat or cold.
2. Long storage will not harm the battery pack or charger. Under proper conditions, they can be stored for 5 years or more.

SAVE THESE INSTRUCTIONS FOR FUTURE USE

COMPONENTS (FIG. 2)

⚠ WARNING: Never modify the power tool or any part of it. Damage or personal injury could result.

- | | |
|-----------------------------|---|
| A. Trigger switch | F. Mode control collar |
| B. Forward/reverse button | G. Gear shifter |
| C. LED light | H. Side handle (DCD950-XE, DCD960-XE, DCD970-XE only) |
| D. Chuck | |
| E. Torque adjustment collar | |

INTENDED USE

These drills/drivers/hammerdrills are designed for professional drilling and screwdriving applications. **DO NOT** use under wet conditions or in presence of flammable liquids or gases.

These drills/drivers/hammerdrills are professional power tools. **DO NOT** let children come into contact with the tool. Supervision is required when inexperienced operators use this tool.

Variable Speed Switch (Fig. 2)

To turn the tool on, squeeze the trigger switch (A). To turn the tool off, release the trigger switch. Your tool is equipped with a brake. The chuck will stop as soon as the trigger switch is fully released.

NOTE: Continuous use in variable speed range is not recommended. It may damage the switch and should be avoided.

Side Handle (Fig. 2)

⚠ WARNING: To reduce the risk of personal injury, **ALWAYS** operate the tool with the side handle properly installed. Failure to do so may result in the side handle slipping during tool operation and subsequent loss of control. Hold tool with both hands to maximize control.

Side handle (H) clamps to the front of the gear case and may be rotated 360° to permit right- or left-hand use. Side handle must be tightened sufficiently to resist the twisting action of the tool if the accessory binds or stalls. Be sure to grip the side handle at the far end to control the tool during a stall.

If model is not equipped with side handle, grip drill with one hand on the handle and one hand on the battery pack.

FIG. 2

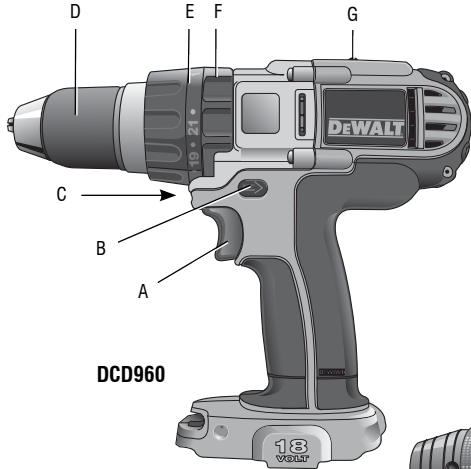

DCD960

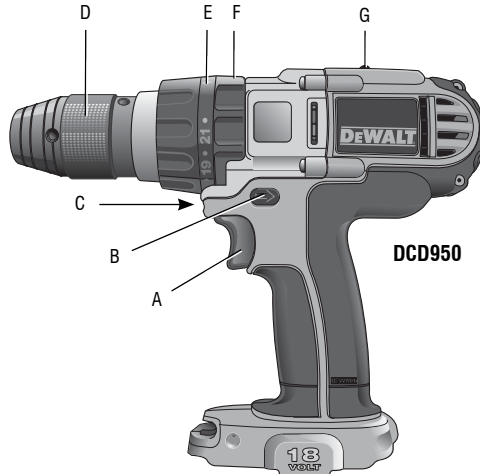
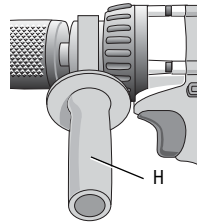

DCD950

NOTE: Side handle comes equipped on models DCD950-XE, DCD960-XE and DCD970-XE.

Forward/Reverse Control Button (Fig. 2)

A forward/reverse control button (B) determines the direction of the tool and also serves as a lock off button.

To select forward rotation, release the trigger switch and depress the forward/reverse control button on the right side of the tool.

To select reverse, release the trigger switch and depress the forward/reverse control button on the left side of the tool.

The center position of the control button locks the tool in the OFF position. When changing the position of the control button, be sure the trigger is released.

NOTE: The first time the tool is run after changing the direction of rotation, you may hear a click on start up. This is normal and does not indicate a problem.

Worklight (Fig. 2)

There is a worklight (C) located just above the trigger switch (A). The worklight will be activated when the trigger switch is squeezed.

NOTE: The worklight is for lighting the immediate work surface and is not intended to be used as a flashlight.

Mode Control Collar (Fig. 3–5)

Your drill is equipped with a separate mode control collar (F) to switch between drilling, screwdriving and hammerdrilling mode.

DRILLING (FIG. 3)

CAUTION: When the mode collar is in the drill/hammerdrill mode, the drill will not clutch out regardless of the position of the torque adjustment collar (E).

Rotate the mode control collar (F) so the drill symbol is aligned with the arrow.

FIG. 3

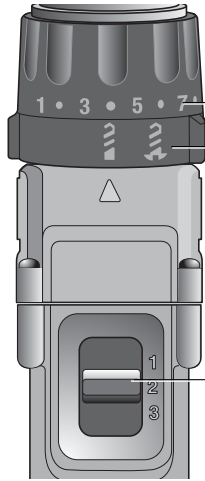

DRILLING

FIG. 4

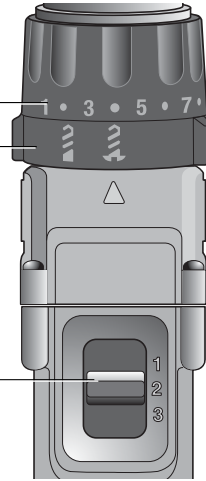

SCREWDRIVING

FIG. 5

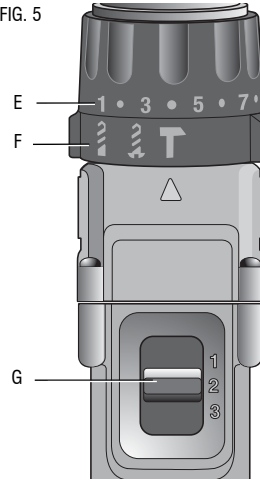

HAMMERDRILLING

NOTE: The torque adjustment collar (E) may be set on any number.

SCREWDRIVING (FIG. 4)

Rotate the mode control collar (F) so the screw symbol is aligned with the arrow.

NOTE: The torque adjustment collar may be set to any number at any time. However, the torque adjustment collar is only engaged during screwdriving mode and not in drill and hammerdrill modes.

HAMMERDRILLING (FIG. 5)

CAUTION: When the mode collar is in the drill/hammerdrill mode, the drill will not clutch out regardless of the position of the torque adjustment collar (E).

Rotate the mode control collar (F) so the hammer symbol is aligned with the arrow.

Torque Adjustment Collar (Fig. 3–5)

Your tool has an adjustable torque screwdriver mechanism for driving and removing a wide array of fastener shapes and sizes. Circling the torque adjustment collar (E) are numbers. These numbers are used to set the clutch to deliver a torque range. The higher the number on the collar, the higher the torque and the larger the fastener which can be driven. To select any of the numbers, rotate until the desired number aligns with the arrow.

Three-Speed Gearing (Fig. 3–5)

The three-speed feature of your tool allows you to shift gears for greater versatility. To select speed 1 (highest torque setting), turn the tool off and permit it to stop. Slide the gear shifter (G) all the way forward. Speed 2 (middle torque and speed setting) is in the middle position. Speed 3 (highest speed setting) is to the rear.

NOTE: Do not change gears when the tool is running. Always allow the drill to come to a complete stop before changing gears. If you have trouble changing gears, make sure that the gear shifter is engaged in one of the three speed settings.

Chucks

WARNING: Do not attempt to tighten drill bits (or any other accessory) by gripping the front part of the chuck and turning the tool on. Damage to the chuck and personal injury may result. Always lock off trigger switch and disconnect tool from power source when changing accessories.

WARNING: Always ensure the bit is secure before starting the tool. A loose bit may eject from tool causing possible personal injury.

KEYLESS SINGLE SLEEVE CHUCK (FIG. 6–8) DCD960-XE, DCD980-XE

Your tool features a keyless chuck with one rotating sleeve for one-handed operation of the chuck. To insert a drill bit or other accessory, follow these steps.

1. Lock the trigger in the OFF position. Turn off tool and disconnect tool from power source.
2. Grasp the black sleeve of the chuck (D) with one hand and use the other hand to secure the tool as shown in Figure 6. Rotate the sleeve counterclockwise (as viewed from the front) far enough to accept the desired accessory.

- Insert the accessory about 19 mm (3/4") into the chuck and tighten securely by rotating the chuck sleeve clockwise with one hand while holding the tool with the other hand. Continue to rotate the chuck sleeve until several ratchet clicks are heard to ensure full gripping power.

FIG. 6

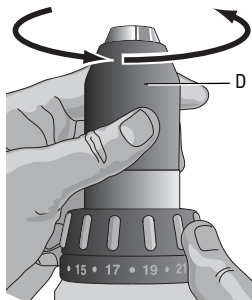

FIG. 7

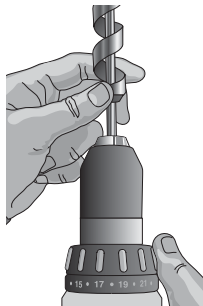
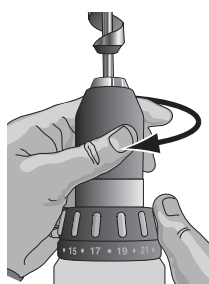

FIG. 8



To release the accessory, repeat Steps 1 and 2 above.

Be sure to tighten chuck with one hand on the chuck sleeve and one hand holding the tool for maximum tightness.

FIG. 9

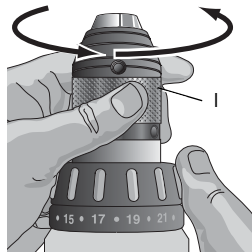

FIG. 10

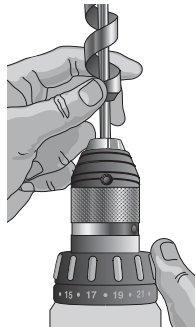
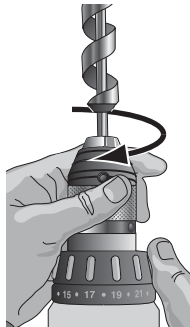

FIG. 11



SELF-TIGHTENING CHUCK OPERATION (FIG. 9–11)

DCD950-XE, DCD970-XE, DCD990-XE

To insert a drill bit or other accessory:

- Lock the trigger in the OFF position. Turn off tool and disconnect tool from power source.
- Grasp the chuck sleeve (I) with one hand and use the other hand to secure the tool as shown in Figure 9. Rotate the sleeve counterclockwise (as viewed from the front) far enough to accept the desired bit or accessory.
- Insert the bit or other accessory about 19 mm (3/4") into the chuck, as shown in Figure 10. Grasp the chuck sleeve (I) securely and rotate the sleeve clockwise (viewed from the front) with one hand while using the other hand to secure the tool. Rotate the sleeve clockwise until sleeve cannot be rotated any further, as demonstrated in Figure 11. As the drill is being operated in the forward position, the chuck will continually self tighten the jaws of the chuck onto the bit or accessory to maximize the bit gripping strength.

To release the accessory, repeat Steps 1 and 2.

OPERATION

FIG. 12

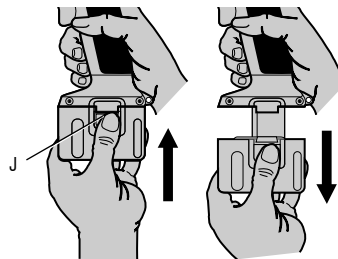

Installing and Removing the Battery Pack (Fig. 12)

NOTE: Make sure your battery pack is fully charged.

To install the battery pack into the tool handle, align the notch inside the tool's handle with the battery pack and slide the battery pack firmly into the handle until you hear the lock snap into place as shown in Figure 12.

To remove the battery pack from the tool, press the release buttons (J) and firmly pull the battery pack out of the tool handle. Insert it into the charger as described in the charger section of this manual.

Drill Operation

1. Select the desired speed/torque range using the gear shifter to match the speed and torque to the planned operation. Set the mode control collar to the drill symbol.
2. For WOOD, use twist bits, spade bits, power auger bits or hole saws. For METAL, use high-speed steel twist drill bits or hole saws. Use a cutting lubricant when drilling metals. The exceptions are cast iron and brass which should be drilled dry.
3. Always apply pressure in a straight line with the bit. Use enough pressure to keep the drill bit biting, but do not push hard enough to stall the motor or deflect the bit.
4. Hold tool firmly with both hands to control the twisting action of the drill.
5. **IF DRILL STALLS**, it is usually because it is being overloaded. **RELEASE TRIGGER IMMEDIATELY**, remove drill bit from work, and determine cause of stalling. **DO NOT CLICK TRIGGER OFF AND ON IN AN ATTEMPT TO START A STALLED DRILL – THIS CAN DAMAGE THE DRILL.**
6. Keep the motor running when pulling the bit back out of a drilled hole. This will help prevent jamming.

Screwdriver Operation

1. Select the desired speed/torque range using the three-speed gear shifter (G) on the top of tool to match the speed and torque to the planned application. Initially set the torque adjustment collar (E) at a lower setting to ensure the fastener to be set to your specification.
NOTE: Use the lowest torque setting required to seat the fastener at the desired depth. The lower the number, the lower the torque output.
2. Rotate the mode control collar (F) so the screw symbol is aligned with the arrow.
3. Reset the torque adjustment collar (E) to the appropriate number setting for the torque desired. Make a few practice runs in scrap or unseen areas to determine the proper position of the torque adjustment collar.

NOTE: The torque adjustment collar may be set to any number at any time. However, the torque adjustment collar is only engaged during screwdriving mode and not in drill and hammerdrill modes.

Hammerdrill Operation

1. Select the desired speed/torque range using the gear shifter to match the speed and torque to the planned operation. Set the mode control collar to the hammer symbol.
2. When drilling, use just enough force on the hammer to keep it from bouncing excessively. Too much force will cause slower drilling speeds, overheating, and a lower drilling rate.
3. Drill straight, keeping the bit at a right angle to the work. Do not exert side pressure on the bit when drilling as this will cause clogging of the bit flutes and a slower drilling speed.
4. When drilling deep holes, if the hammer speed starts to drop off, pull the bit partially out of the hole with the tool still running to help clear debris from the hole.
5. For MASONRY, use carbide-tipped bits or masonry bits. A smooth, even flow of dust indicates the proper drilling rate.

MAINTENANCE

⚠ WARNING: To reduce the risk of personal injury, turn unit off and remove battery pack before installing and removing accessories, before adjusting or when making repairs. To prevent inadvertent operation, lock the trigger switch when the tool is not in use and when storing the tool.

Cleaning

⚠ WARNING: Blow dirt and dust out of all air vents with clean, dry air at least once a week. To minimize the risk of eye injury, always wear ANSI Z87.1 approved eye protection when performing this.

⚠ WARNING: Never use solvents or other harsh chemicals for cleaning the non-metallic parts of the tool. These chemicals may weaken the materials used in these parts. Use a cloth dampened only with water and mild soap. Never let any liquid get inside the tool; never immerse any part of the tool into a liquid.

CHARGER CLEANING INSTRUCTIONS

⚠ WARNING: Shock hazard. Disconnect the charger from the AC outlet before cleaning. Dirt and grease may be removed from the exterior of the charger using a cloth or soft non-metallic brush. Do not use water or any cleaning solutions.

Repairs

This charger is not user serviceable. There are no user serviceable parts inside the charger. Servicing at an authorized service center is required to avoid damage to static sensitive internal components.

To assure product SAFETY and RELIABILITY, repairs, maintenance and adjustment (including brush inspection and replacement) should be performed by certified service centers or other qualified service organizations, always using identical replacement parts.

ACCESSORIES

⚠ WARNING: Since accessories, other than those offered by DEWALT, have not been tested with this product, use of such accessories with this tool could be hazardous. To reduce the risk of injury, only DEWALT, recommended accessories should be used with this product.

Recommended accessories for use with your tool are available at extra cost from your local service center. If you need any assistance in locating any accessory, please contact DEWALT Industrial Tool Co., 20 Fletcher Road, Mooroolbark, VIC 3138 Australia or call 1800 654 155 or (NZ) 0800 339258.

MAXIMUM RECOMMENDED CAPACITIES

	Speed 1	Speed 2	Speed 3
BITS, METALDRILLING	12.7 mm (1/2")	6.4 mm (1/4")	6.4 mm (1/4")
WOOD, FLATBORING	38.1 mm (1-1/2")	15.9 mm (5/8")	15.9 mm (5/8")
BITS, MASONRYDRILLING	–	6.4 mm (1/4")	6.4 mm (1/4")

Guarantee

Applicable to hand held Power Tools, Lasers and Nailers.

Three Year Limited Warranty

DEWALT will repair, without charge, any defects due to faulty materials or workmanship for three years from the date of purchase. Please return the complete unit, transportation prepaid, to any DEWALT Service Centre, or any authorised service station.

For warranty repair information, call (AUS) 1800 654 155 or (NZ) 0800 339258.

This warranty does not apply to

- Accessories

- Damage caused where repairs have been made or attempted by others.
- Damage due to misuse, neglect, wear and tear, alteration or modification.

This warranty gives you specific legal rights and you may have other rights under the provisions of the Consumer Guarantee Act 1993 (New Zealand only), Trade Practices Act 1974 and State Legislation (Australia only).

In addition to the warranty, DEWALT tools are covered by our:

FREE ONE YEAR SERVICE CONTRACT

DEWALT will also maintain the tool for free at any time during the first year of purchase. This includes labour, parts and lubrication required to restore the product to sound mechanical and/or electrical condition. Normal wear parts are not covered in this service. Carbon brushes worn more than 50% will be replaced.

NOTE: Three Year Warranty is not applicable to items deemed as consumables. Radial arm saws are covered by a one (1) year warranty only. DEWALT Reserves the right to review its warranty policy prior to launch of any new business development products.

30 DAY NO SATISFACTION GUARANTEE

If you are dissatisfied with any DEWALT power tool, laser or nailer, for any reason, simply return it to the point of purchase with your sales receipt within 30 days for a replacement unit or a full refund.

FREE WARNING LABEL REPLACEMENT: If your warning labels become illegible or are missing, call (AUS) 1800 654 155 or (NZ) 0800 339258 for a free replacement.

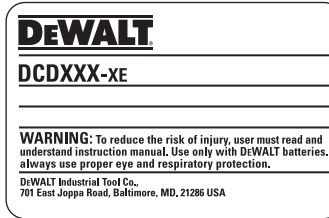

DeWALT BATTERY AND CHARGER SYSTEMS																					
Battery		Output Nominal	Chargers/Charge Time																		
Cat. Number	Voltage	Amp Hour	240 Volts																	12 Volts	
			97014	98014	DW9106	DW9107	DW9108	DW9115	DW9116	DW9117	DW9118	DE9116	DE9118	DW9111	DC011	DW0245	DE2046	DE9000	DC9310	DW9109	DC9319
DC9036	36	2.2	X	X	X	X	X	X	X	X	X	X	X	X	X	X	X	60	X	X	X
DE0240-XJ	24	2.0	X	X	X	X	X	X	X	X	X	X	X	X	X	60	60	X	X	X	X
DW0242	24	2.0	X	X	X	X	X	X	X	X	X	X	X	X	X	60	60	X	X	X	X
DW0240	24	1.7	X	X	X	X	X	X	X	X	X	X	X	X	X	60	60	X	X	X	X
DC9096	18	2.4	X	X	X	X	60	X	60	20	X	60	X	60	60	X	X	X	60	60	60
DC9180	18	2.0	X	X	X	X	X	X	X	X	X	X	X	X	X	X	X	X	60	X	60
DW9096	18	2.4	X	X	X	X	60	X	60	20	X	60	X	60	60	X	X	X	60	60	60
DE9095-XJ	18	2.0	X	X	X	X	60	X	60	20	X	60	X	60	60	X	X	X	60	60	60
DC9091	14.4	2.4	60	60	60	60	15	60	15	60	60	60	60	60	60	X	X	X	60	60	60
DC9144	14.4	2.0	X	X	X	X	X	X	X	X	X	X	X	X	X	X	X	X	60	X	60
DE9091-XJ	14.4	2.0	45	45	45	45	45	15	45	15	90	45	90	45	45	X	X	X	45	45	45
DW9091	14.4	1.7	45	45	45	45	45	15	45	15	90	45	90	45	45	X	X	X	45	45	45
DC9071	12	2.4	60	60	60	60	60	15	60	15	60	60	60	60	60	X	X	X	60	60	60
DE9071-XJ	12	2.0	60	60	60	45	45	15	45	15	90	45	90	45	45	X	X	X	45	45	45
DE9074-XJ	12	1.25	45	45	45	30	30	15	30	12	60	30	60	30	30	X	X	X	30	30	30
DW9050	12	1.3	40	40	40	X	X	15	X	X	X	X	X	X	X	X	X	X	X	X	X
DW9071	12	1.7	60	60	60	45	45	15	45	15	90	45	90	45	45	X	X	X	45	45	45
DW9072	12	1.2	45	45	45	30	30	15	30	12	60	30	60	30	30	X	X	X	30	30	30
DW9063	9.6	1.25	45	45	45	30	30	15	30	12	60	30	60	30	30	X	X	X	30	30	30
DW9062	9.6	1.3	45	45	45	30	30	15	30	12	60	30	60	30	30	X	X	X	30	30	30
DW9061	9.6	1.7	60	60	60	45	45	15	45	15	90	45	90	45	45	X	X	X	45	45	45
DW9048	9.6	1.3	40	40	40	X	X	15	X	X	X	X	X	X	X	X	X	X	X	X	X
DW9057	7.2	1.25	45	45	45	30	30	15	30	12	60	30	60	30	30	X	X	X	30	30	30
DW9046	7.2	1.3	40	40	40	X	X	15	X	X	X	X	X	X	X	X	X	X	X	X	X

X Indicates that the battery pack is not compatible with that specific charger.
All charge times are approximate. Actual charge time may vary.
Read the instruction manual for more specific information.
The battery voltage is nominal, it can measure above or below depending on the state of charge.

DeWALT Industrial Tool Co.,

701 East Joppa Road, Baltimore, MD 21286 • 20 Fletcher Road, Mooroolbark, VIC 3138 Australia

(DEC08) Part No. N022098 DCD950-XE, DCD960-XE, DCD970-XE, DCD980-XE, DCD990-XE Copyright © 2008 DeWALT

The following are trademarks for one or more DeWALT power tools: the yellow and black color scheme; the “D” shaped air intake grill; the array of pyramids on the handgrip; the kit box configuration; and the array of lozenge-shaped humps on the surface of the tool.